

9111 Series

H.D. 2.0mm(0.079") Futurebus(+) 4 Rows Male Power Type

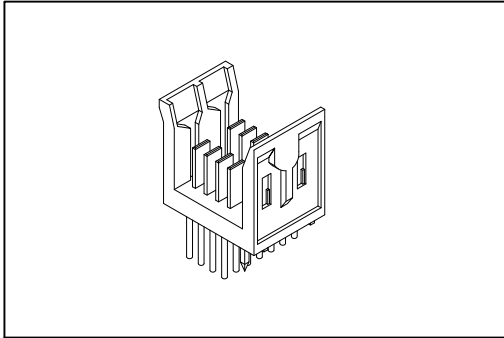

Material:

Housing: High Temperature Plastic UL94V-0.
Contacts: Copper Alloy.

Electrical Characteristics:

Current Rating: 3 A.
Dielectric Withstanding Voltage: AC 1000V.
Insulator Resistance: 1000MΩ min.
Contact Resistance: 30mΩ max.
Operating Temperature: -55°C ~+125°C.

Features:

- * 2mm high density futurebus+ male power solder and press fit type.
- * 8 pins.
- * High current rating.
- * Side by side stackable.

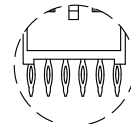
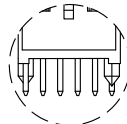
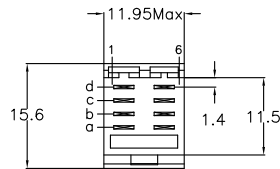

Dip Type

Press Fit Type

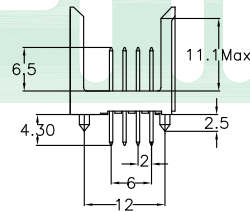
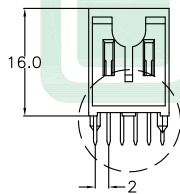

Option A

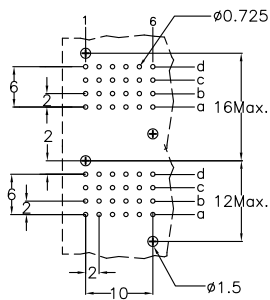

P.C. Board Layout

Ordering information

<u>9111-</u>	<u>4</u>	<u>3</u>	<u>08</u>	<u>A</u>	<u>C</u>	<u>10</u>	<u>D</u>	<u>U</u>
Series	4: 4Rows	3: Male Power	Position	A: (A,B,E) See Page CD25	C: Selective Gold Plated	10: 10 μ"	D: Dip Type P: Press Fit Type	U: Tube Package

9111 Series

H.D. 2.0mm(0.079") Futurebus(+)Connector Special Custom Loading Form



Signal Type

Male Custom Solder Tail Length Lay-out and Male Custom Premating Lay-out.

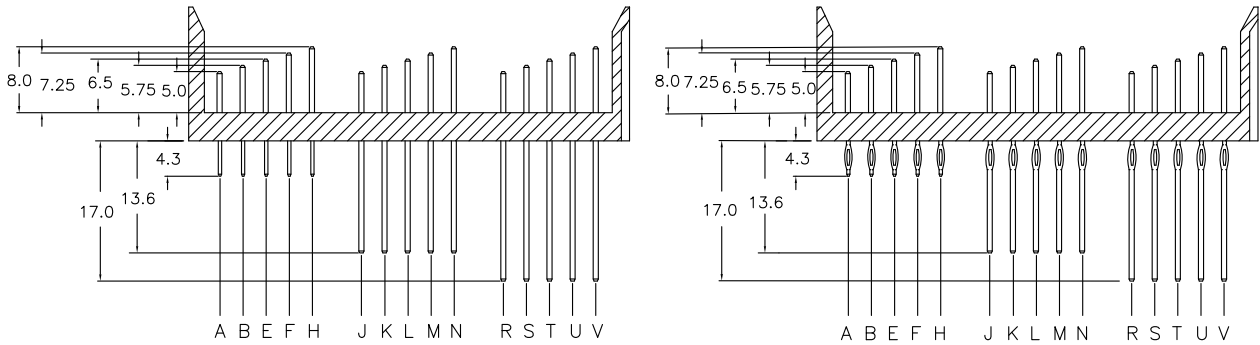
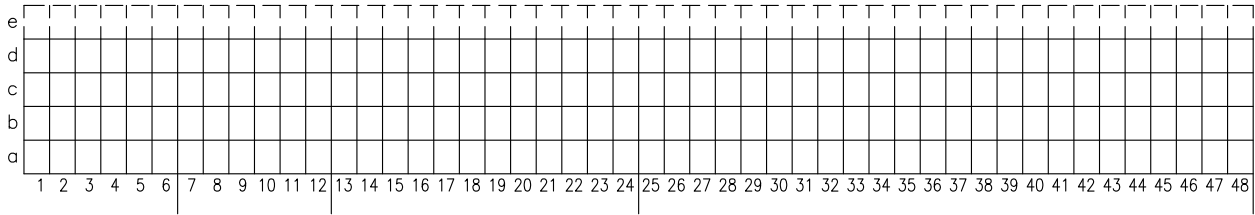

Power Type

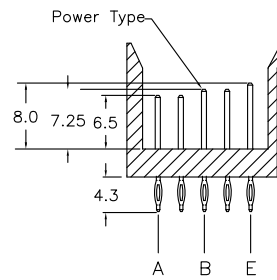
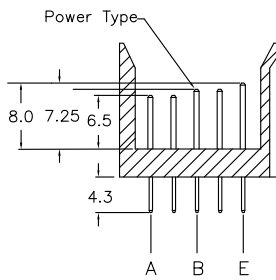
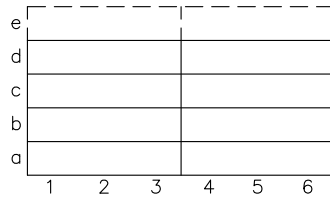

* Other Custom lay-out please consult to factory.

Information including designs, specifications and components may be changed or updated without notice.